

Can-Am

**Mill Chain
Sprockets**

Can-Am Products

visit us at www.can-amchains.com

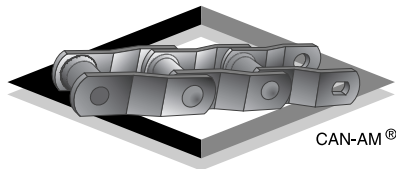

CAN-AM®

The origin of CAN-AM chain dates back to 1966, and a small machine shop in Richmond, BC. Today three plants with more than 210,000 square feet of manufacturing space, support 10 sales branches from coast to coast, making us the largest producer of welded steel and specialty chains in North America.

HEAD OFFICE CANADA

8355 128th Street
Surrey, B.C. V3W 4G1
Phone (604) 599-1522
Fax (604) 599-4115
Shipping (604) 594-5811
Toll Free 1-800-663-3136

BRITISH COLUMBIA BRANCH

9661 Penn Road
Prince George, BC V2N 5T6
Phone (250) 562-7727
Fax (250) 562-9603
Toll Free 1-877-399-3136

ALBERTA BRANCH

Unit 5 – 2002 8th Street
Nisku, Alberta T9E 7Y8
Phone (780) 955-3993
Fax (780) 955-3994
Toll Free 1-800-832-7556

ONTARIO BRANCH

5050 Dufferin Street
North York, Ontario M3H 5T5
Phone (416) 663-2626
Fax (416) 663-0774
Toll-Free 1-800-648-4225

HEAD OFFICE USA

115151 S.E. Minuteman Way
P.O. Box 453
Clackamas, OR 97015
Phone (503) 657-1158
Fax (503) 656-7549
Toll Free 1-800-547-6274

SHREVEPORT BRANCH

2095 N. Hearne Ave.
Shrevenport, LA 71107
Phone (318) 227-8006
Fax (318) 424-7751
Toll Free 1-800-321-8846

ALABASTER BRANCH

600 Galloway Circle
Alabaster, AL 35007
Phone (205) 942-2617
Fax (205) 942-4975
Toll Free 1-800-824-0674

ROCKY MOUNT BRANCH

7010 Stanley Park Dr.
Rocky Mount, NC 27804
Phone (252) 451-0636
Fax (252) 451-0833
Toll Free 1-888-856-0744

CANADA

E-mail:
cansales@can-amchains.com

USA

E-mail:
usasales@can-amchains.com

Fabricated Steel Sprockets4

Mill Chain Sprockets5

Drag Chain Sprockets6

Long Link Sprockets and Idlers7

Sprockets for Rivetless Chain8

142mm CDM Ash System9

Sprocket Ordering Guide11

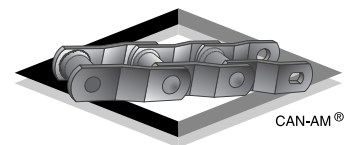

Challenge Us Today!

CAN-AM FABRICATED STEEL SPROCKETS are normally made of mild steel plate. Heat treated plate sprockets with hardnesses from 360 to 500 BHN are available. Unless otherwise requested, O.D. of hubs will be sufficient to accommodate bore and keyway desired. Keys are not supplied

Chain Number	Number of Teeth	Pitch Dia.	Max. Bore	Tooth Face
WR-78, H-78	7	6.01	2 3/16	1
MOH-578*	8	6.82	2 7/16	1
SS-578*	9	7.63	2 11/16	1
MS-88*	10	8.44	2 15/16	1
MO-88*	11	9.26	3 7/16	1
LXS-882*	12	10.08	3 7/16	1
81-X*	13	10.90	3 15/16	1
C-188*	14	11.72	4 15/16	1
PITCH=2.609"	15	12.55	4 15/16	1
	16	13.37	4 15/16	1
	17	14.20	4 15/16	1
	18	15.02	4 15/16	1
	19	15.85	4 15/16	1
	20	16.88	5 15/16	1

* Tooth face is 7/8"

Most flame cut sprockets supplied from stock.

Chain Number	Number of Teeth	Pitch Dia.	Max. Bore	Tooth Face
WR-78XHD	7	6.01	2 3/16	1
PITCH=2.609"	8	6.82	2 7/16	1
	9	7.63	2 11/16	1
	10	8.44	2 15/16	1
	11	9.26	3 7/16	1
	12	10.08	3 7/16	1
	13	10.90	3 15/16	1
	14	11.72	4 15/16	1
	15	12.55	4 15/16	1
	16	13.37	4 15/16	1
	17	14.20	4 15/16	1
	18	15.02	4 15/16	1
	19	15.85	4 15/16	1
	20	16.88	5 15/16	1

with these items unless requested or unless mounted on shafts. Split sprockets provide an economical means of mounting sprockets on shafts where it is prohibitive to dismount the shaft assembly. Many sizes of sprockets are stocked with bores, keyways, and set screws already provided. Plates or partially finished sprockets are also stocked. In the case of long link sprockets and idlers, please specify the size of chain that will be used. Bronze and urethane bushing material is stocked for immediate insertion.

Chain Number	Number of Teeth	Pitch Dia.	Max. Bore	Tooth Face
WR-82	7	7.09	2 7/16	1 1/8
PITCH=3.075"	8	8.04	3 15/16	1 1/8
	9	8.99	4 15/16	1 1/8
	10	9.95	5 7/16	1 1/8
	11	10.91	5 15/16	1 1/8
	12	11.88	5 15/16	1 1/8
	13	12.85	5 15/16	1 1/8
	14	13.82	5 15/16	1 1/8
	15	14.79	5 15/16	1 1/8
	16	15.76	5 15/16	1 1/8
	17	16.73	5 15/16	1 1/8
	18	17.71	5 15/16	1 1/8
	20	19.66	5 15/16	1 1/8
WR-82XHD	7	7.09	2 7/16	1 1/8
WRC-131*	8	8.04	3 15/16	1 1/8
C-131	9	8.99	4 15/16	1 1/8
PITCH 3.075	10	9.95	5 7/16	1 1/8
	11	10.91	5 15/16	1 1/8
	12	11.88	5 15/16	1 1/8
	13	12.85	5 15/16	1 1/8
	14	13.82	5 15/16	1 1/8
	15	14.79	5 15/16	1 1/8
	16	15.76	5 15/16	1 1/8
	17	16.73	5 15/16	1 1/8
	18	17.71	5 15/16	1 1/8
	20	19.66	5 15/16	1 1/8

SPROCKETS

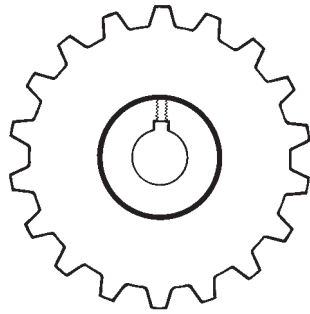

Chain Number	Number of Teeth	Pitch Dia.	Max. Bore	Tooth Face
H-130/138	6	8.00	2 7/16	1
WR-78-4	7	9.22	3 7/16	1
PITCH=4.000"	8	10.45	4 15/16	1
	9	11.70	5 15/16	1
	10	12.94	5 15/16	1
	11	14.20	5 15/16	1
	12	15.45	5 15/16	1
	16	20.50	5 15/16	1
WR-124	6	8.00	2 7/16	1 1/2
C-102B	7	9.22	2 15/16	1 1/2
PITCH=4.000"	8	10.45	3 7/16	1 1/2
	9	11.66	3 15/16	1 1/2
	10	12.94	4 15/16	1 1/2
	11	14.20	4 15/16	1 1/2
	12	15.46	4 15/16	1 1/2
	13	16.72	5 15/16	1 1/2
	14	17.98	5 15/16	1 1/2
	15	19.23	5 15/16	1 1/2
	16	20.50	5 15/16	1 1/2
	18	23.04	5 15/16	1 1/2
	20	25.57	5 15/16	1 1/2
WR-106	6	12.00	4 15/16	1 1/2
PITCH=6.000	8	15.68	4 15/16	1 1/2
	9	17.54	5 15/16	1 1/2
	10	19.42	5 15/16	1 1/2
	11	21.30	5 15/16	1 1/2
	12	23.18	5 15/16	1 1/2
	13	25.07	5 15/16	1 1/2
WR-106XHD	6	12.00	4 15/16	1 1/2
PITCH=6.050	8	15.68	4 15/16	1 1/2
	9	17.54	5 15/16	1 1/2
	10	19.42	5 15/16	1 1/2
	11	21.30	5 15/16	1 1/2
	12	23.18	5 15/16	1 1/2
	13	25.07	5 15/16	1 1/2

Most flame cut sprockets, finished bore K+S.S. or T.K. are supplied from stock. Hardened sprockets also available.

Chain Number	Number of Teeth	Pitch Dia.	Max. Bore	Tooth Face
WR-124HD	7	9.36	2 7/16	1 1/2
WR-124XHD	8	10.62	3 15/16	1 1/2
PITCH=4.063"	9	11.88	4 15/16	1 1/2
	10	13.15	5 7/16	1 1/2
	11	14.42	5 15/16	1 1/2
	12	15.70	5 15/16	1 1/2
	13	16.98	5 15/16	1 1/2
	14	18.26	5 15/16	1 1/2
	15	19.54	5 15/16	1 1/2
	16	20.83	5 15/16	1 1/2
	17	22.11	5 15/16	1 1/2
	18	23.40	5 15/16	1 1/2
	20	25.97	5 15/16	1 1/2
WR-111	8	12.44	4 15/16	2
PITCH=4.760"	9	13.91	4 15/16	2
	10	15.40	4 15/16	2
	11	16.90	5 15/16	2
	12	18.39	5 15/16	2
	13	19.89	5 15/16	2
	14	21.39	5 15/16	2
	16	24.40	5 15/16	2
	17	25.90	5 15/16	2
	18	27.41	5 15/16	2
	20	30.43	5 15/16	2
	24	36.47	5 15/16	2
	26	39.49	5 15/16	2
	28	42.51	5 15/16	2
WR-132	8	15.81	5 15/16	2 3/4
WRC-132	9	17.69	6 15/16	2 3/4
WR-132XHD	10	19.58	6 15/16	2 3/4
WRC-132XHD	11	21.47	6 15/16	2 3/4
WR/WH-157	12	23.38	6 15/16	2 3/4
WH-200	13	25.28	6 15/16	2 3/4
WR-150	14	27.19	6 15/16	2 3/4
WR-155	15	29.10	6 15/16	2 3/4
WR-159	16	31.01	6 15/16	2 3/4
PITCH=6.050"	18	34.84	6 15/16	2 3/4

DRAG CHAIN SPROCKETS

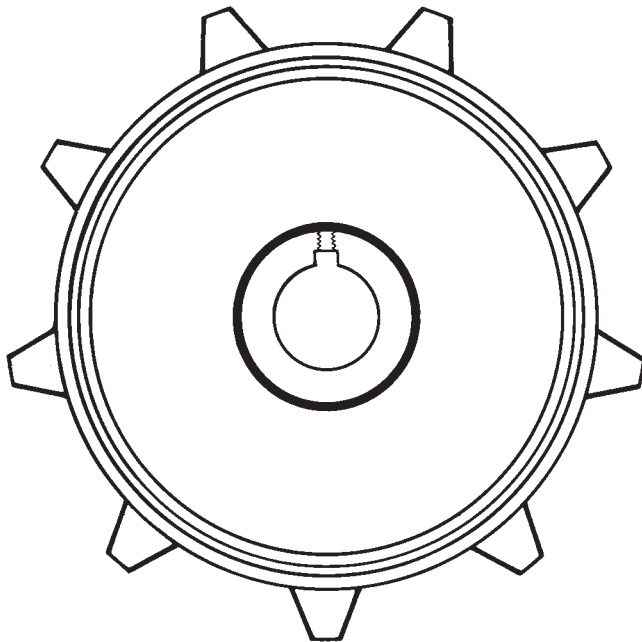

FABRICATED DRUM
C/W CAST STEEL
"LONG LIFE" TEETH

Chain Number	Number of Teeth	Pitch Dia.	Max. Bore	Tooth Face
WD-102 PITCH=5.000"	6	10.00	3 15/16	6 3/8
	8	13.07	5 15/16	6 3/8
	9	14.62	5 15/16	6 3/8
	10	16.18	5 15/16	6 3/8
	12	19.32	5 15/16	6 3/8
WD-104 PITCH=6.000"	8	15.68	4 15/16	4 1/8
	9	17.54	5 15/16	4 1/8
	10	19.42	5 15/16	4 1/8
WD-110 WD-113 PITCH=6.000"	6	12.00	4 7/16	9
	8	15.68	5 15/16	9
	9	17.54	5 15/16	9
	10	19.42	5 15/16	9
WD-112 PITCH=8.000"	7	18.44	4 15/16	9
	8	20.90	5 15/16	9
	9	23.39	5 15/16	9

Chain Number	Number of Teeth	Pitch Dia.	Max. Bore	Tooth Face
WD-116 PITCH=8.000"	7	18.44	5 7/16	13
	8	20.90	5 15/16	13
	9	23.39	5 15/16	13
WD-118 PITCH=8.000"	7	18.44	5 7/16	13
	8	20.90	5 15/16	13
	9	23.39	5 15/16	13
WD-120 PITCH=6.000"	6	12.00	5 15/16	8 3/4
	8	15.68	5 15/16	8 3/4
	11	21.30	5 15/16	8 3/4
WD-122 PITCH=8.000"	6	16.00	5 7/16	8 3/4
	7	18.44	5 7/16	8 3/4
	9	23.39	5 15/16	8 3/4
WD-480 PITCH=8.000"	6	16.00	5 7/16	11
	7	18.44	5 7/16	11
	8	20.90	5 15/16	11
	9	23.39	5 15/16	11
	11	28.40	5 15/16	11

Drag chain sprockets are recommended with a full width tooth to extend chain life. Specify flange width, as the sprockets and idlers are only as wide as the tooth face.

LONG LINK SPROCKETS available in fabricated steel and cast steel.

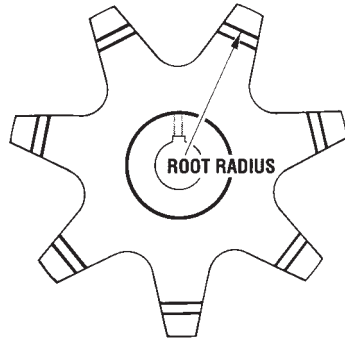

	Chain Size	Horizontal Pitch Diameter	Tooth Face
5 TOOTH	3/4 x 1 1/2 x 6	18.205	1 1/4
	7/8 x 1 1/2 x 6	18.158	1 1/4
	1 x 1 1/2 x 6	18.111	1 1/4
	* 1 x 1 3/4 x 6	18.111	1 1/2
	* 1 1/8 x 2 x 6	18.062	1 1/2
	1 1/4 x 2 x 6	18.012	1 3/4
	1 1/4 x 2 x 8	24.180	1 3/4
	1 1/2 x 2 1/4 x 8	24.082	2
6 TOOTH	3/4 x 1 1/2 x 6	22.177	1 1/4
	7/8 x 1 1/2 x 6	22.140	1 1/4
	1 x 1 1/2 x 6	22.100	1 1/4
	* 1 x 1 3/4 x 6	22.100	1 1/2
	* 1 1/8 x 2 x 6	22.060	1 1/2
	1 1/4 x 2 x 6	22.019	1 3/4
	1 1/4 x 2 x 8	29.493	1 3/4
	1 1/2 x 2 1/4 x 8	29.413	2
7 TOOTH	3/4 x 1 1/2 x 6	26.105	1 1/4
	7/8 x 1 1/2 x 6	26.072	1 1/4
	1 x 1 1/2 x 6	26.039	1 1/4
	* 1 x 1 3/4 x 6	26.039	1 1/2
	* 1 1/8 x 2 x 6	26.005	1 1/2
	1 1/4 x 2 x 6	25.970	1 3/4
	1 1/4 x 2 x 8	34.741	1 3/4
	1 1/2 x 2 1/4 x 8	34.673	2

LONG LINK IDLERS are available with fabricated steel center, cast steel center or manganese center groove.

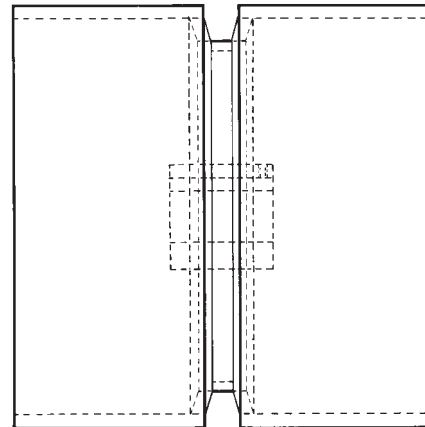

Diameter	Face	Stock	Diameter	Face	Stock
14	12	1/2	24	14	1/2
14	14	1/2	24	16	1/2
14	16	1/2	24	18	1/2
14	18	1/2	24	20	1/2
14	20	1/2	24	22	1/2
16	12	1/2	24	24	1/2
16	14	1/2	24	26	1/2
16	16	1/2	24	28	1/2
16	18	1/2	24	30	1/2
16	20	1/2	30	16	1/2
18	14	1/2	30	18	1/2
18	16	1/2	30	20	1/2
18	18	1/2	30	22	1/2
18	20	1/2	30	24	1/2
18	22	1/2	30	26	1/2
18	24	1/2	30	28	1/2
20	14	1/2	30	30	1/2
20	16	1/2			
20	18	1/2			
20	20	1/2			
20	22	1/2			
20	24	1/2			

Any diameter or width can be furnished with any size hub or bore. All sizes in inches. Specify chain size when ordering.

For longer chain life use 7 tooth pattern.
*Denotes most common chain sizes.

SPROCKETS FOR RIVETLESS CHAIN are normally supplied in fabricated high-carbon steel. Available in Solid, Split, Removable Rim or Split Removable Rim.

Solid

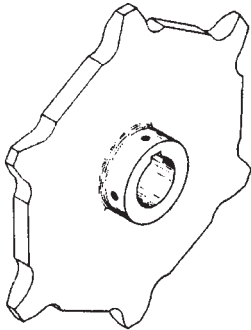

Chain	Teeth	Pitch Diameter
	3	8.00
	4	10.45
	5	12.94
458/X-458	6	15.45
	7	17.97
	8	20.50
	9	23.03
	4	15.68
	5	19.41
678/X-678	6	23.18
	7	26.96
	8	30.75
	9	34.56
	4	15.68
	5	19.41
	6	23.18
698	7	26.96
	8	30.75
	9	34.56

Removable Rim

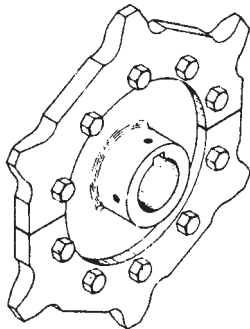

WE CAN MAKE YOUR SPECIAL SPROCKETS

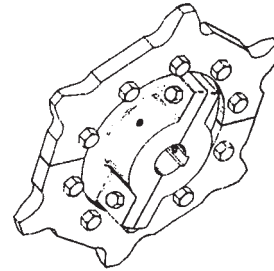

Split Bolted Segmental Rim Sprocket

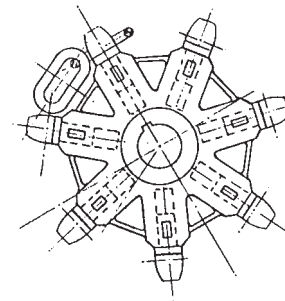

Special Sprocket Drive and Head Shaft Assemblies

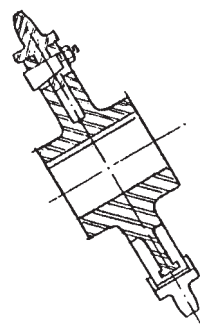
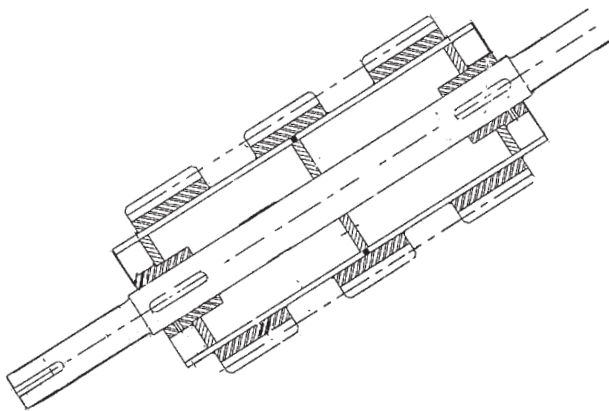

Replaceable Tooth Cast Steel Long Link Chain Sprocket

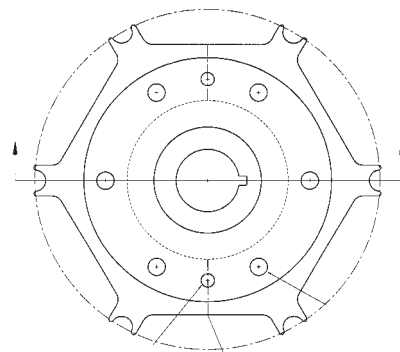

CDM SYSTEMS SPROCKETS

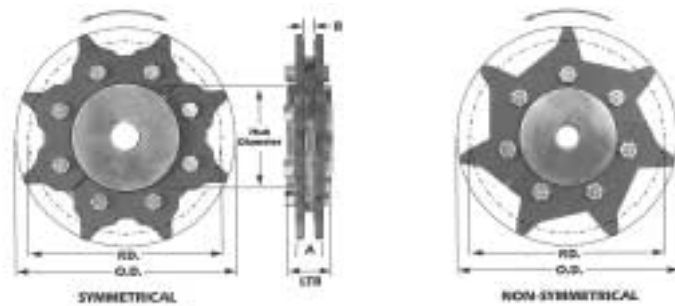

	Tooth/Bolt	P.D.	O.D.	Chain O.D.	A	B	Max Bore	Hub Dia.	LTB	Weight
102 Series *Sym. Only	6TS/6B	8.03" 204mm	8.50 216	9.375 238	1.375 35	.50 12.7	2.4375 62	3.375 86	2.250 57	13 lbs 5.9 kg
	8TS/8B	10.49" 266mm	11.00 280	11.625 295	1.375 35	.50 12.7	3.4375 87	5.25 133	2.25 57	30 lbs 13.65 kg
	10TS/10B	12.99" 330mm	13.50 343	14.375 365	1.375 35	.50 12.7	3.9375 100	7.50 190	2.25 57	50 lbs 22.7 kg
142 STD Series *Sym.	6TS/6B	11.18" 284mm	11.8 300	13.25 337	1.97 50	.67 17	3.0 76.2	4.25 108	2.75 70	35 lbs 15.90 kg
	7TS/7B	12.88" 327mm	13.5 343	15.0 381	1.97 50	.67 17	3.9375 100	5.875 149.2	2.75 70	50 lbs 22.73 kg
	8TS/8B	14.6" 371mm	15.25 387	16.69 424	1.97 50	.67 17	5.75 146	7.87 200	2.75 70	84 lbs 38.18 kg
	9TS/9B	16.35" 415mm	17.0 432	18.43 468	1.97 50	.67 17	5.75 146	7.87 200	2.75 70	87 lbs 39.55 kg
	10TS/10B	18.09" 459mm	19.25 489	20.19 513	1.97 50	.67 17	6.50 165	9.50 241	2.75 70	140 lbs 63.64 kg
	11TS/11B	19.84" 504mm	21.06 535	21.94 557	1.97 50	.67 17	7.0 178	11.0 279	3.15 80	165 lbs 75 kg
	14TS/14B	25.12" 638mm	26.37 670	27.24 692	1.97 50	.67 17	7.0 178	11.0 279	4.72 120	255 lbs 115.90 kg
142 STD Series **Non Sym.	6TN/6B	11.18" 284mm	11.8 300	13.25 337	1.97 50	.67 17	3.0 76.2	4.25 108	2.75 70	35 lbs 15.90 kg
	7TN/7B	12.88" 327mm	13.5 343	15.0 381	1.97 50	.67 17	3.9375 100	5.875 149.2	2.75 70	50 lbs 22.73 kg
	8TN/8B	14.6" 371mm	15.25 387	16.69 424	1.97 50	.67 17	5.75 146	7.87 200	2.75 70	84 lbs 38.18 kg
	9TN/9B	16.35" 415mm	17.0 432	18.43 468	1.97 50	.67 17	5.75 146	7.87 200	2.75 70	87 lbs 39.55 kg
	10TN/10B	18.09" 459mm	19.25 489	20.19 513	1.97 50	.67 17	6.50 165	9.50 241	2.75 70	140 lbs 63.64 kg
	11TN/11B	19.84" 504mm	21.06 535	21.94 557	1.97 50	.67 17	7.0 178	11.0 279	3.15 80	165 lbs 75 kg
	14TN/14B	25.12" 638mm	26.37 670	27.24 692	1.97 50	.67 17	7.0 178	11.0 279	4.72 120	255 lbs 115.90 kg
142 HVY Series *Sym.	7TS/7B	12.88" 327mm	13.5 343	15.0 381	2.75 70	.75 19.05	3.9375 100	5.875 149.2	3.54 90	80 lbs 36.4 kg
	8TS/8B	14.6" 371mm	15.25 387	16.69 424	2.75 70	.75 19.05	5.75 146	7.87 200	3.54 90	98 lbs 44.55 kg
	9TS/9B	16.35" 415mm	17.0 432	18.43 468	2.75 70	.75 19.05	5.75 146	7.87 200	3.54 90	119 lbs 54.09 kg
	10TS/10B	18.09" 459mm	19.25 489	20.19 513	2.75 70	.75 19.05	6.50 165	9.50 241	3.54 90	164 lbs 74.55 kg
	11TS/11B	19.84" 504mm	21.06 535	21.94 557	2.75 70	.75 19.05	7.0 178	11.0 279	3.54 90	210 lbs 95.45 kg
	14TS/14B	25.12" 638mm	26.37 670	27.24 692	2.75 70	.75 19.05	7.0 178	11.0 279	4.72 120	320 lbs 145.45 kg
	142 HVY Series **Non Sym.	7TN/7B	12.88" 327mm	13.5 343	15.0 381	2.75 70	.75 19.05	3.9375 100	5.875 149.2	3.54 90
8TN/8B		14.6" 371mm	15.25 387	16.69 424	2.75 70	.75 19.05	5.75 146	7.87 200	3.54 90	98 lbs 44.55 kg
9TN/9B		16.35" 415mm	17.0 432	18.43 468	2.75 70	.75 19.05	5.75 146	7.87 200	3.54 90	119 lbs 54.09 kg
10TN/10B		18.09" 459mm	19.25 489	20.19 513	2.75 70	.75 19.05	6.50 165	9.50 241	3.54 90	164 lbs 74.55 kg
11TN/11B		19.84" 504mm	21.06 535	21.94 557	2.75 70	.75 19.05	7.0 178	11.0 279	3.54 90	210 lbs 95.45 kg
14TN/14B		25.12" 638mm	26.37 670	27.24 692	2.75 70	.75 19.05	7.0 178	11.0 279	4.72 120	320 lbs 145.45 kg
175 STD Series **Non Sym. Only		6TN/6B	13.78" 350mm	14.0 356	16.14 410	2.44 62	1.18 30	4.9375 125	7.28 185	4.72 120
	8TN/8B	17.99" 457mm	18.25 464	20.35 517	2.44 62	1.18 30	6.5 165	10.0 254	4.72 120	175 lbs 79.55 kg
	10TN/10B	22.28" 566mm	22.6 574	24.65 626	2.44 62	1.18 30	9.0 228.6	13.5 343	4.72 120	305 lbs 138.6 kg

*Sym. = Symmetrical **Non-Sym. = Non Symmetrical

TERMINAL & SPLIT RIM IDLERS

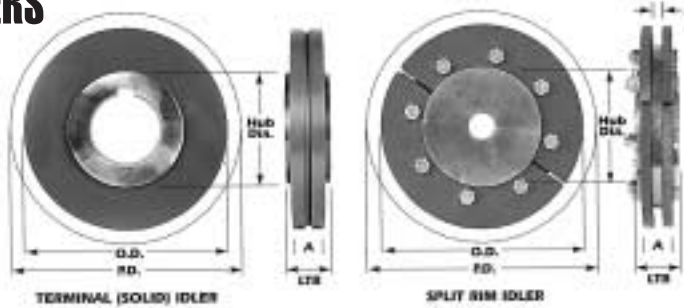

	Idler Size	Idler O.D.	P.D	Chain O.D.	A	Hub Diameter	LTB	Max Bore	Bolts Req'd	Weight
102 Series Solid Only	145	5.70" 145mm	8.00 203	9.375 238	1.25 31.75	QD	1.25 31.75	2.625 66.7	—	10 lbs 4.5 kg
	213	8.40" 213mm	10.48 266	11.625 295	1.25 31.75	QD	1.25 31.75	2.625 66.7	—	20 lbs 9.1 kg
		10.90" 277mm	12.83 326	14.17 360	1.25 31.75	QD	1.25 31.75	2.625 66.7	—	30 lbs 13.6 kg
	142 STD Solid	198	7.80" 198mm	11.25 286	13.39 340	1.97 50	4.72 120	2.36 60	2.94 75	—
289		11.375" 289mm	14.49 368	16.61 422	1.97 50	7.087 180	2.75 70	3.94 100	—	63 lbs 28.6 kg
		12.625" 321mm	15.63 397	17.76 451	1.97 50	7.087 180	2.75 70	3.94 100	—	75 lbs 34.1 kg
345		13.58" 345mm	16.54 420	18.66 474	1.97 50	9.45 240	3.15 80	6.50 165	—	100 lbs 45.5 kg
		17.20" 437mm	19.96 507	22.09 561	1.97 50	9.45 240	3.15 80	6.50 165	—	150 lbs 68.2 kg
557		21.93" 557mm	24.53 623	26.65 677	1.97 50	8.0 203	4.0 102	6.50 165	—	245 lbs 111.4 kg
		142 STD Series Split Rim	289 SR	11.375" 289mm	14.49 368	16.61 422	1.97 50	7.87 200	2.75 70	3.94 100
321 SR	13.625" 321mm		15.63 397	17.76 451	1.97 50	7.87 200	2.75 70	3.94 100	8	75 lbs 34.1 kg
	13.58" 345mm		16.54 420	18.66 474	1.97 50	7.87 200	2.75 70	6.50 165	8	100 lbs 45.5 kg
437 SR	17.20" 437mm		19.96 507	22.09 561	1.97 50	9.50 241	2.75 70	6.50 165	10	150 lbs 68.2 kg
	21.93" 557mm		24.53 623	26.65 677	1.97 50	11.0 279	3.15 80	6.50 165	11	245 lbs 111.4 kg
142 HVY Series Solid	198	7.80" 198mm	11.25 286	13.39 340	2.75 70	—	2.75 70	2.94 75	—	35 lbs 15.9 kg
	289	11.375" 289mm	14.49 368	16.61 422	2.75 70	—	2.75 70	3.94 100	—	75 lbs 34.1 kg
		12.625" 321mm	15.63 397	17.76 451	2.75 70	—	2.75 70	3.94 100	—	95 lbs 43.2 kg
	345	13.58" 345mm	16.54 420	18.66 474	2.75 70	9.45 240	3.15 80	6.50 165	—	110 lbs 50 kg
		17.20" 437mm	19.96 507	22.09 561	2.75 70	9.45 240	3.15 80	6.50 165	—	185 lbs 84.1 kg
	557	21.93" 557mm	24.53 623	26.65 677	2.75 70	8.0 203	4.0 102	6.50 165	—	305 lbs 138.6 kg
		142 HVY Series Split Rim	289 SR	11.375" 289mm	14.49 368	16.61 422	2.75 70	7.87 200	2.75 70	3.94 100
321 SR	12.625" 321mm		15.63 397	17.76 451	2.75 70	7.87 200	2.75 70	3.94 100	8	95 lbs 43.2 kg
	13.58" 345mm		16.54 420	18.66 474	2.75 70	7.87 200	2.75 70	6.50 165	8	110 lbs 50 kg
437 SR	17.20" 437mm		19.96 507	22.09 561	2.75 70	9.50 241	2.75 70	6.50 165	10	185 lbs 84.1 kg
	21.93" 557mm		24.53 623	26.65 677	2.75 70	11.0 279	3.15 80	6.50 165	11	305 lbs 138.6 kg
175 STD Series Solid Only	243	9.567" 243mm	13.779 350	16.14 410	2.84 72	7.28 185	3.54 90	4.9375 125	—	80 lbs 36.4 kg
	362	14.252" 362mm	17.992 457	20.35 517	2.84 72	10.0 254	3.54 90	6.5 165	—	175 lbs 79.6 kg
		18.858" 479mm	22.283 566	24.65 626	2.84 72	13.5 343	3.54 90	9.0 228.6	—	295 lbs 134.1 kg

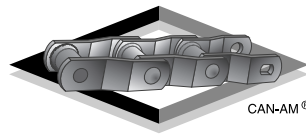

SPROCKET INFORMATION GUIDE

MILL CHAIN SPROCKETS

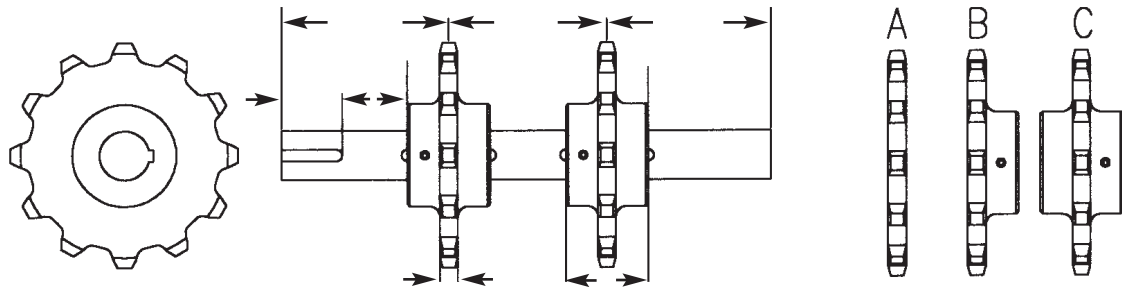

DRAG CHAIN SPROCKETS

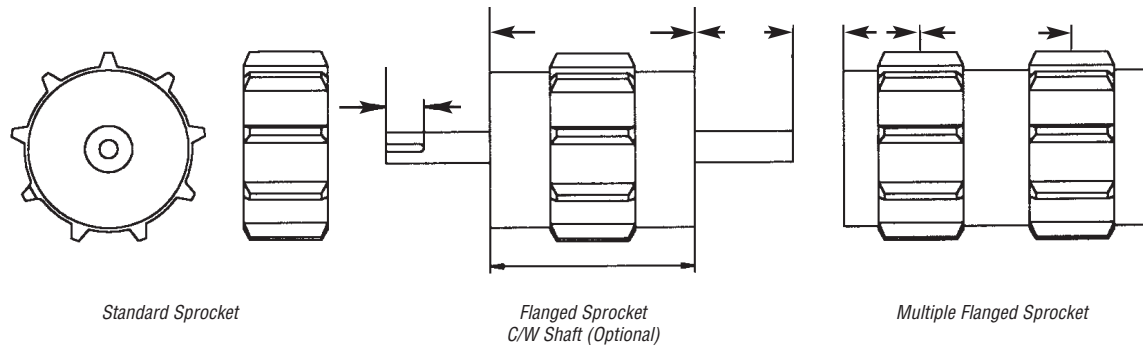

Standard Sprocket

Flanged Sprocket
C/W Shaft (Optional)

Multiple Flanged Sprocket

ORDER GUIDE

Qty.	To Fit Chain Size	# of Teeth	Hub Style	Bore	Shaft Fit	Keyway <input type="checkbox"/> STD; <input type="checkbox"/> SPEC	Flanged <input type="checkbox"/> Yes; <input type="checkbox"/> No	Mounted on Shaft
					<i>Sliding or Shrink Fit</i>			<i>Yes or No</i>
								<i>*Indicate dimensions on the Shaft Assembly diagram (above).</i>

STANDARD HUB DETAILS

HUB O.D., KEYWAY & SET SCREW SIZES

1 7/16" Bore	1 15/16" Bore	2 7/16" Bore	2 15/16" Bore	3 7/16" Bore	3 15/16" Bore	4 7/16" Bore	4 15/16" Bore	5 7/16" Bore	5 15/16" Bore
4" OD Hub	4" OD Hub	5" OD Hub	5" OD Hub	6" OD Hub	7" OD Hub	7" OD Hub	8" OD Hub	9" OD Hub	10" OD Hub
3/8" Keyway	1/2" Keyway	5/8" Keyway	3/4" Keyway	7/8" Keyway	1" Keyway	1" Keyway	1 1/4" Keyway	1 1/4" Keyway	1 1/2" Keyway
3/8" x 3/8" S.S.	1/2" x 1/2" SS	1/2" x 1/2" SS	5/8" x 5/8" SS	3/4" x 3/4" SS	3/4" x 3/4" SS	3/4" x 3/4" SS	7/8" x 7/8" SS	7/8" x 7/8" SS	1" x 1" SS

**TYPICAL MULTI-CHAIN HEAD DRUM
ORDER INFO PAGE**

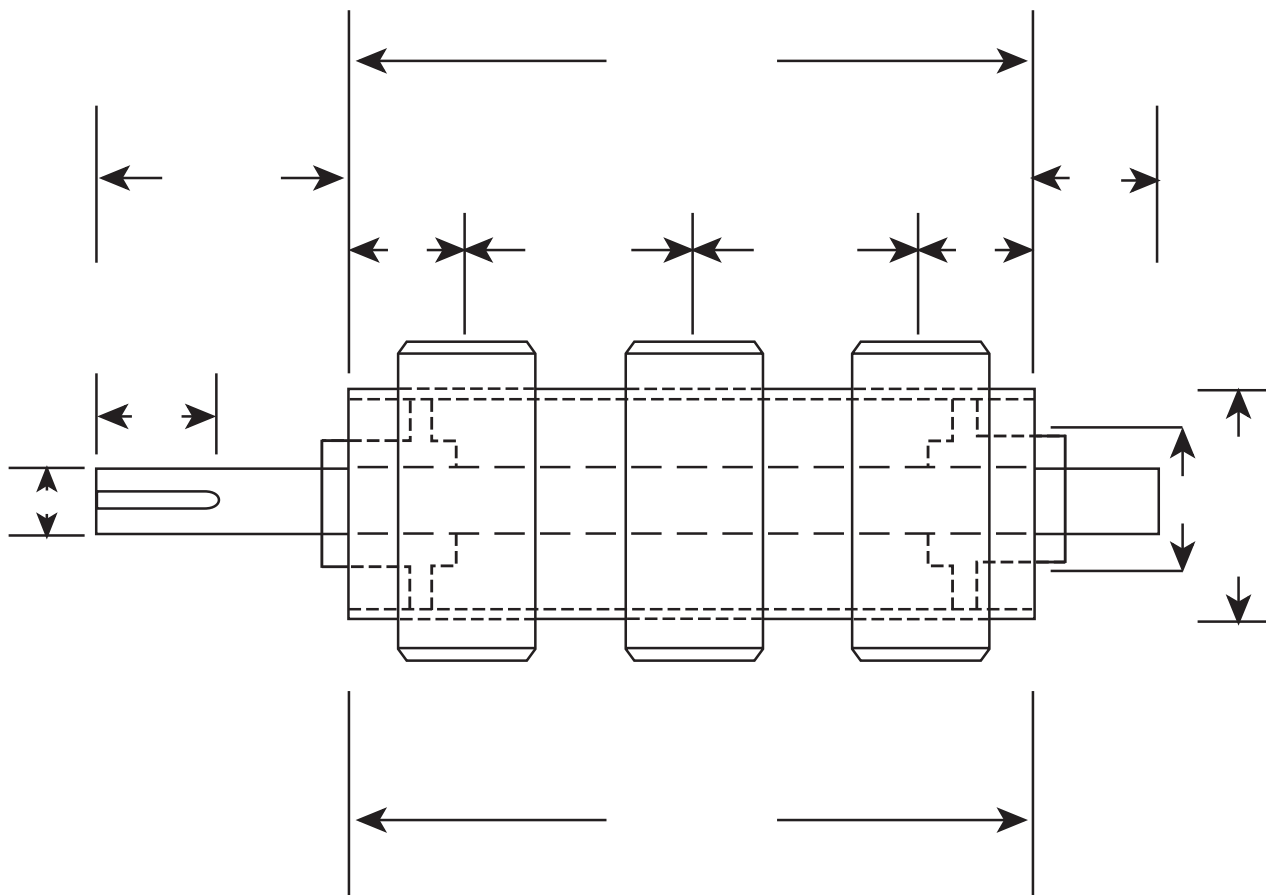

NOTES

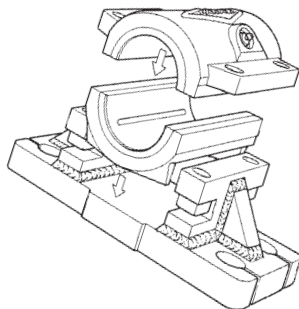
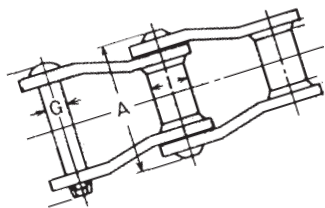
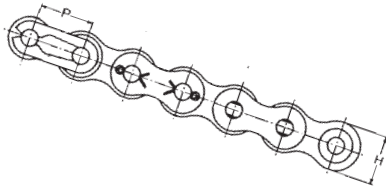
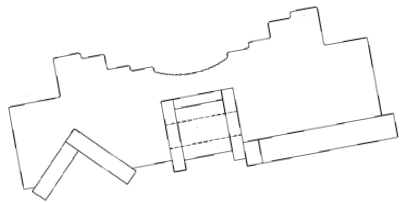
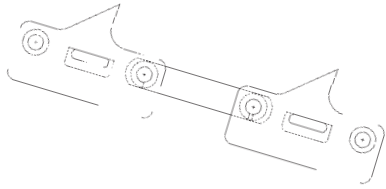

PRODUCTS AND SERVICES PROVIDED BY CAN-AM CHAINS

SHARP CHAINS D.L.I. CHAINS

Can-Am Chain makes a full range of specialty chain and flights to suit all facets of industry. Pictured here are two examples of high speed scanner/canter feed chains for the lumber industry.

CAN-AM ROLLER CHAIN

Built to our exacting standards and requirements to exceed ASNI standards. These chains are all made with solid rollers and bushings.

MILL & DRAG CHAIN

Can-AM's flag ship. We manufacture mill and drag chain for the world.

SPLIT SLEEVE BEARINGS 2-2500 SERIES

Can-Am manufactures a full line of these bearings and stocks them with liners of UHMW, bronze, babbitt or Zinc Aluminum.

Please contact us for further information or visit our web site at www.can-amchains.com

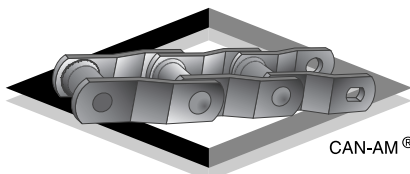

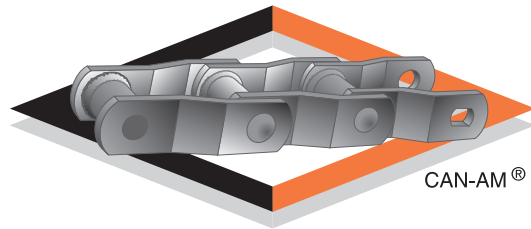
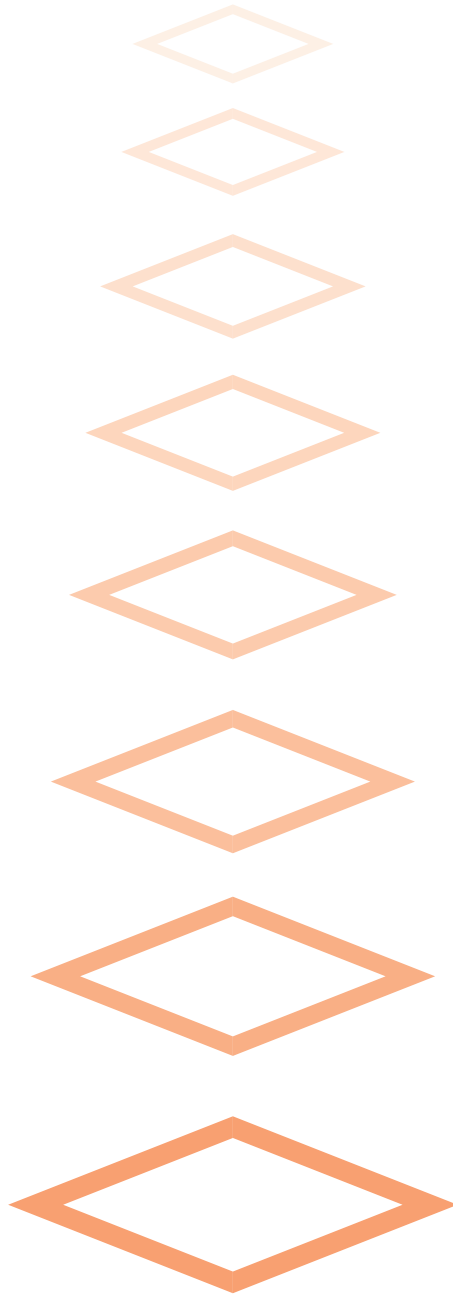

CAN-AM®

Can-Am

Challenge Us Today!